

Anordnung Motor-Klemmenkasten
 A-D wahlweise (C=Standard)
 Arrangement of motor terminal boxes
 A-D optionally (C = standard)

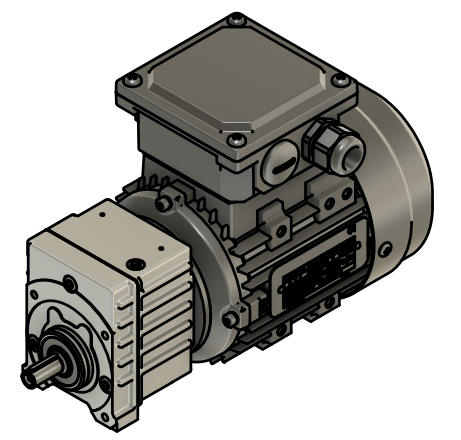

35j6	-0,005	+0,011
10k6	+0,001	+0,010

Toleranzen / Tolerances

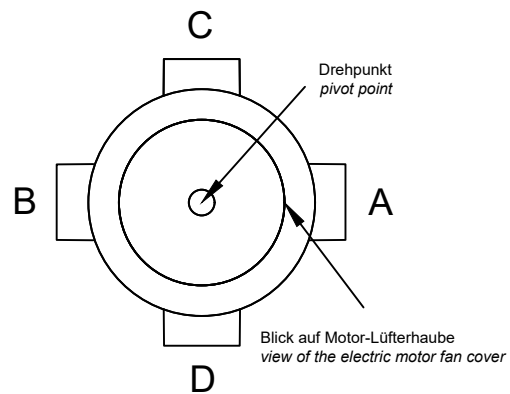
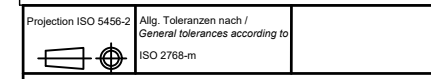

Elektromotoren sind Zukaufteile. Maße können daher abweichen. Alle Maßangaben ohne Gewähr.
 Electric motors are purchased parts. Dimensions can therefore differ. All dimensions without guarantee.



heytraction
 Antriebstechnik GmbH
 Heidemannstraße 3
 DE-80939 München
 www.heytraction.de

Stirnrad-Getriebemotor / Spur Geared Motor
 P= 0,09 kW, Bauform / mounting B14

Benennung / Designation
G23_G27-09-4_B14_KK_C

Zeichnungsnummer / Drawing number
MZ22013020

Maßstab / Scale
 1:2
 Maße in mm
 Dimensions in mm

Erstellt mit CAD-Software Fusion 360 Ausgabedatum Format A3 Blatt 1/1